

SHIN SHIN MARINE

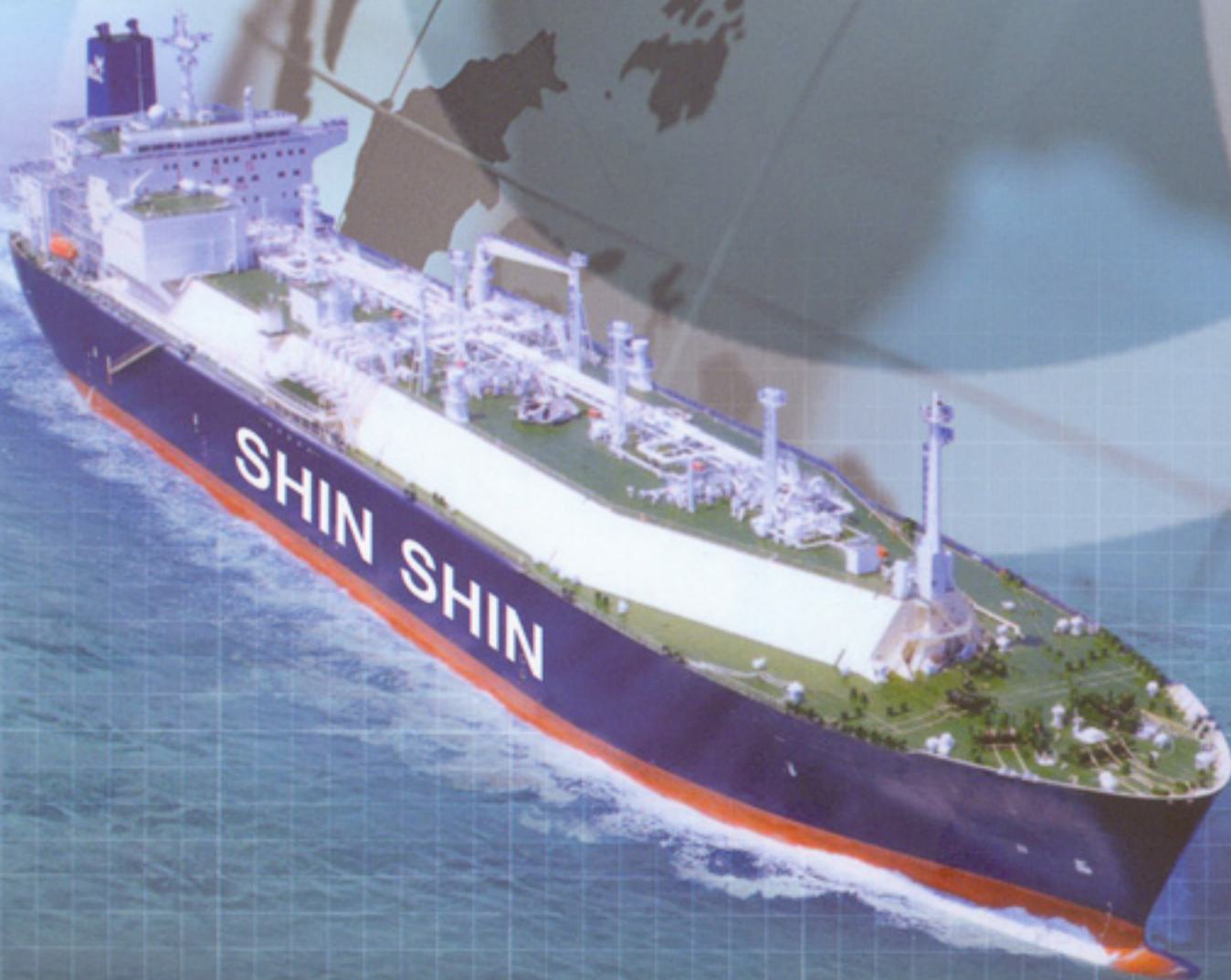

 SHIN SHIN MACHINERY CO., LTD.

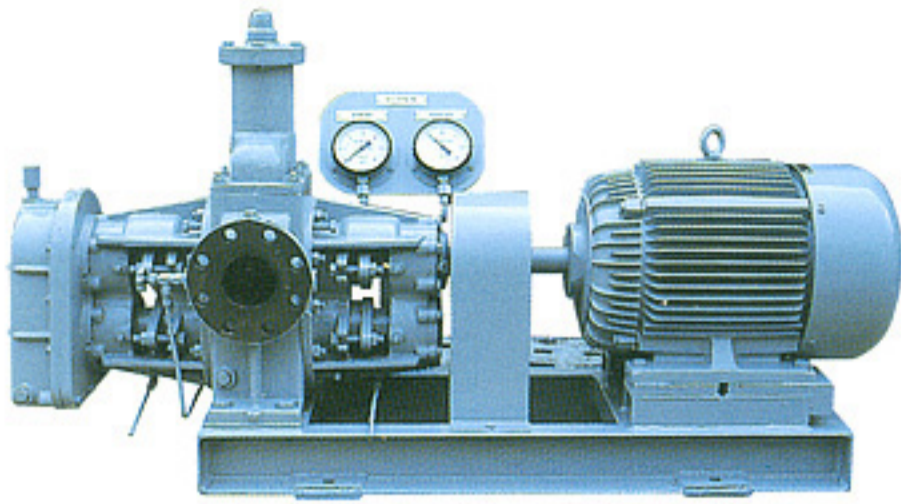

- Applications
 - Blige Stripping Pump
 - Others

■ Principal Particulars

Item	Model	1	2	3	4	5	6	7.5	10	12	15	20	25	30	40	50	65	80	100	
Rotation		Clock viewed from driver end																		
Suction & Discharge bore(mm)	S	φ 20	φ 25		φ 32	φ 40		φ 50			φ 65		φ 80	φ 100	φ 125	φ 150				
	D	φ 20	φ 25		φ 32	φ 40		φ 50			φ 65		φ 80	φ 100	φ 125	φ 150				
Standard Capacity(m ³ /hr)	60Hz	6P	1	2	3	4	5	6	7.5	10	12	15	20	25	30	40	50	-	-	-
		8P	-	-	-	-	-	-	-	-	-	-	-	-	-	-	-	65	80	100
	50Hz	6P	0.8	1.6	2.5	3.3	4	5	6	8	10	12	16	20	25	33	40	-	-	-
		8P	-	-	-	-	-	-	-	-	-	-	-	-	-	-	-	55	65	85
Pressure(kg/cm ²)		Up To 7 kg/cm ²																		
Stuffing box seal		Gland Packing																		
Weight	GC (kg)	Refer to the Outline Drawing																		

■ Standard Materials

Part No.	Name Of Part	MATERIAL KS
717	Cap	GC200
714	"O" Ring	Rubber
713	Adjust Screw	SS41
712	Spring Valve Spring	SS41
707	Safety Valve Spring	SPS6
706	Safety Valve Seat	STS304
704	Safety Valve	SM45C
702	Safety Valve Cover	GC200
701	Safety Valve Box	GC200
682	Gear Box Seat	GC200
680	Gear Box	GC200
517	Oil Seal	Rubber
516	Oil Seal	Rubber
515	Oil Seal	Rubber
504	Gland	GC200
503	Packing Seat	SM45C
501	Gland Packing	
383	Grease Cup	
382	Air Breather	SS41
381	Level Gauge	
209	Bearing Cover	GC200
208	Bearing Cover	STB2
201	Ball Bearing	STB2
153	Collar	SM45C
151	Bearing Nut	SS41
150	Bearing Nut	SS41
117	Key	SM45C
115	Drive Gear	SM45C
110	Gear Set Ring	STS304
105	Key	SM45C
103	Pump Gear	SM45C
102	Driven Shaft	SM45C
101	Drive Shaft	SM45C
025	Plate	GC200
003	Side Cover	GC200
001	Casing	GC200

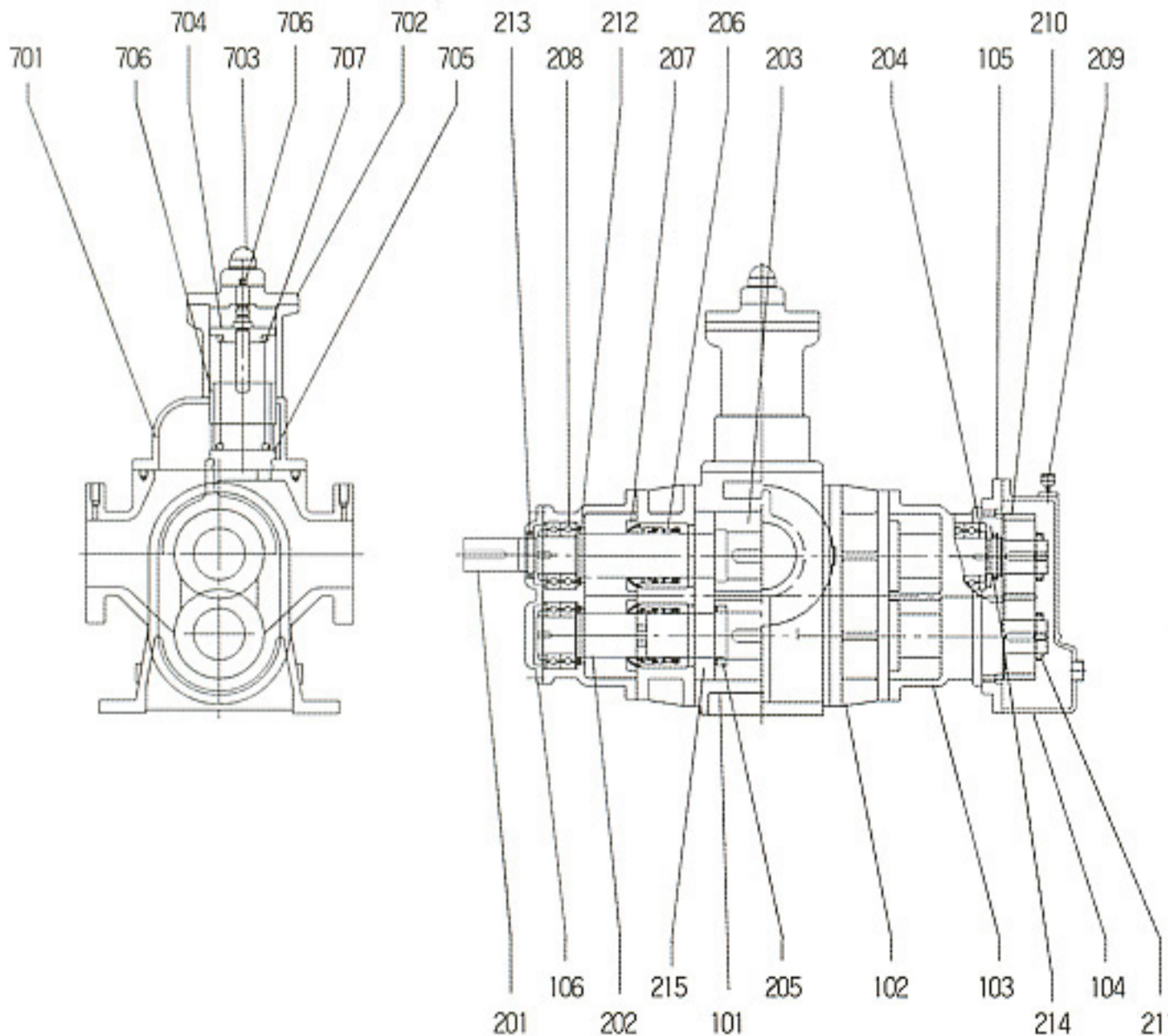

50HZ

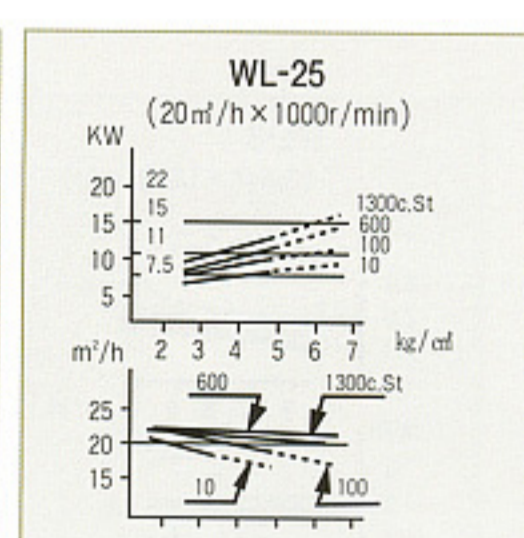
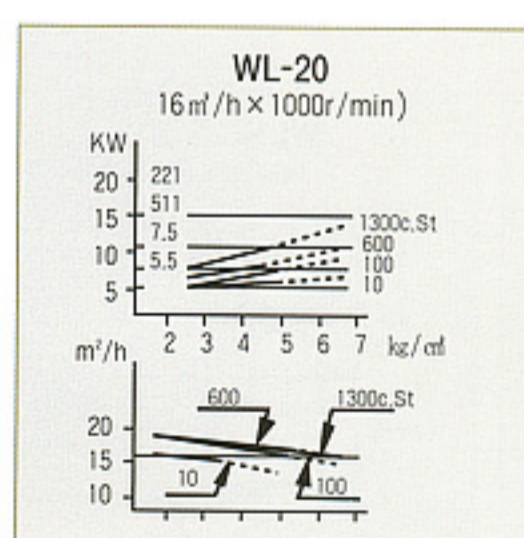
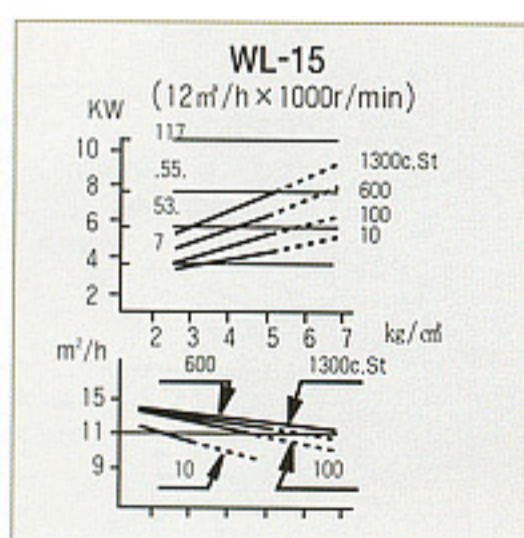
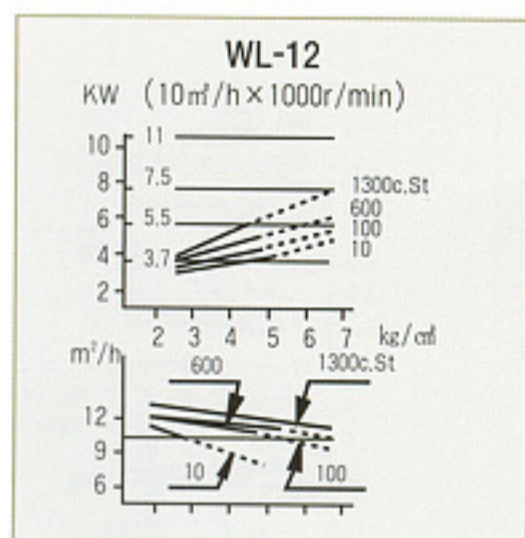
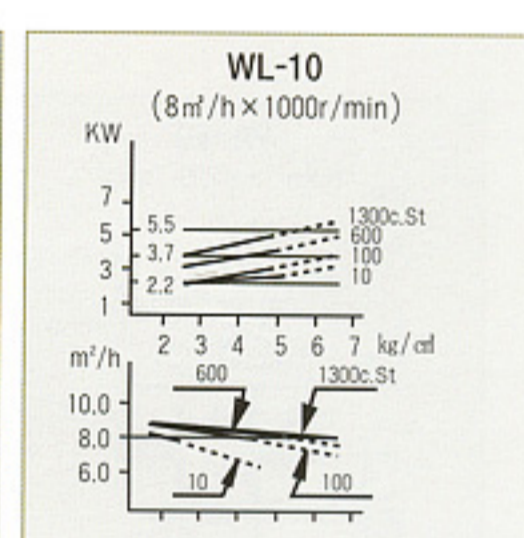
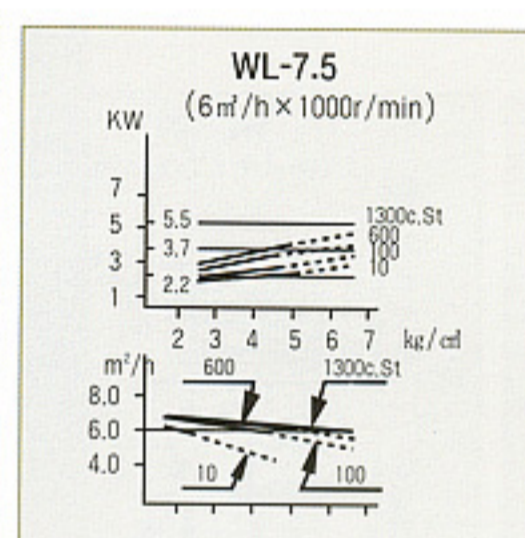
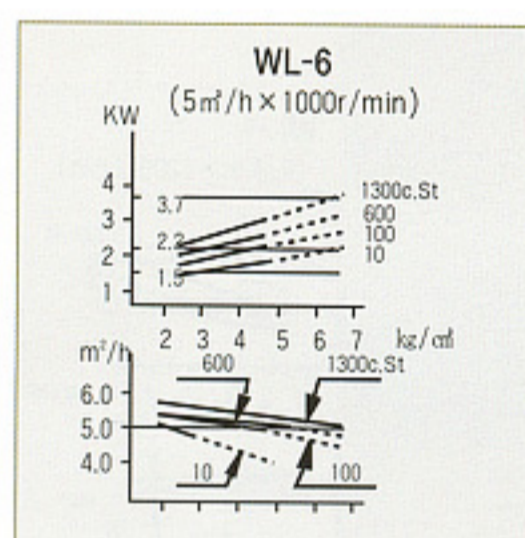
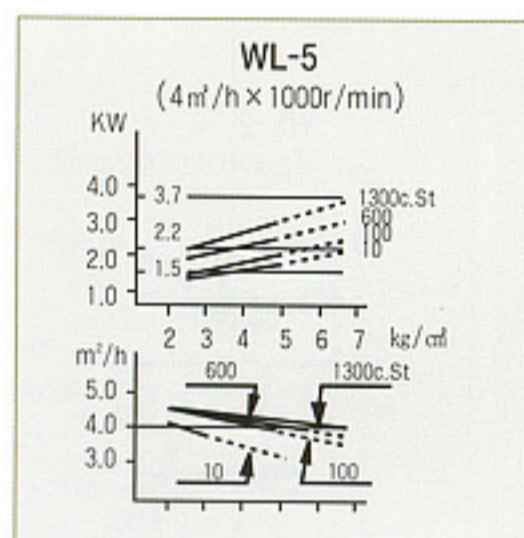
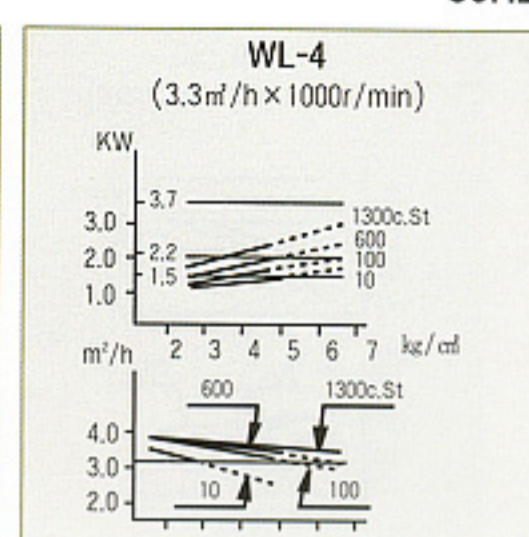
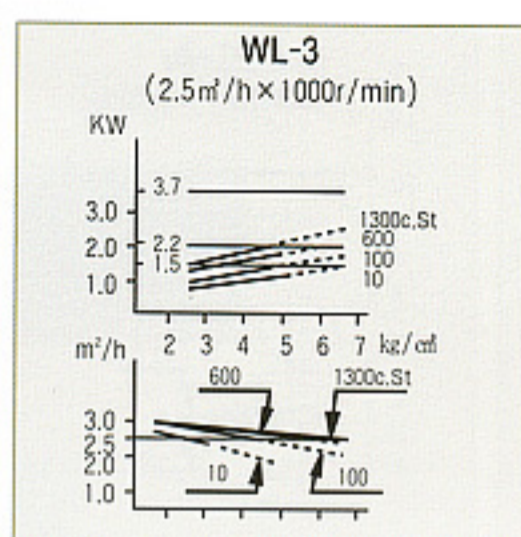
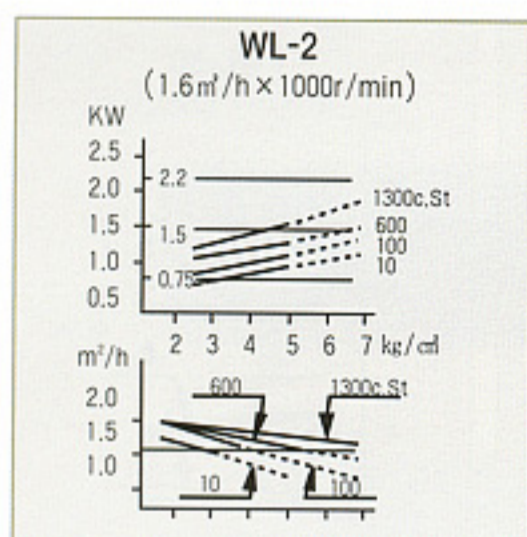
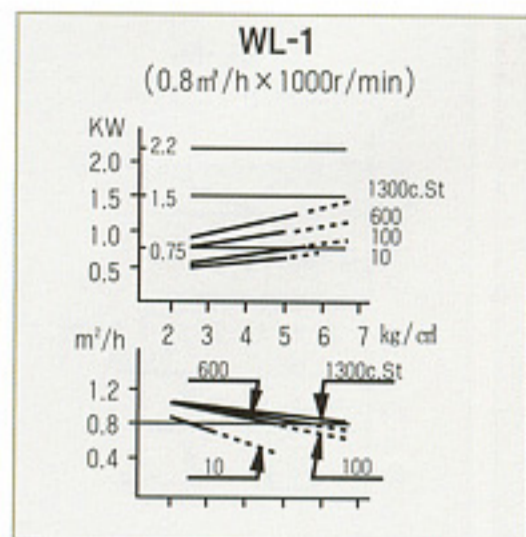

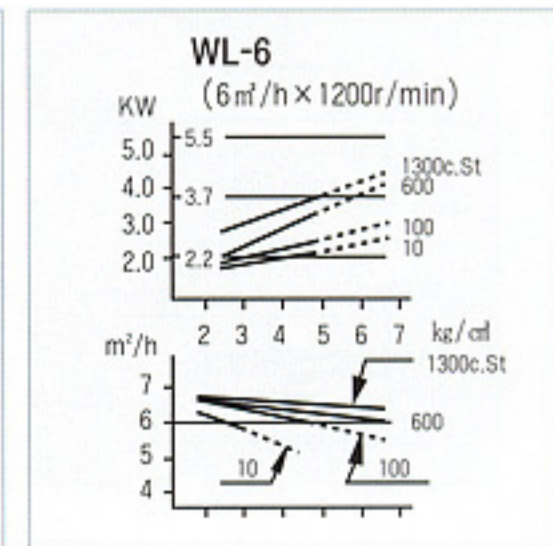
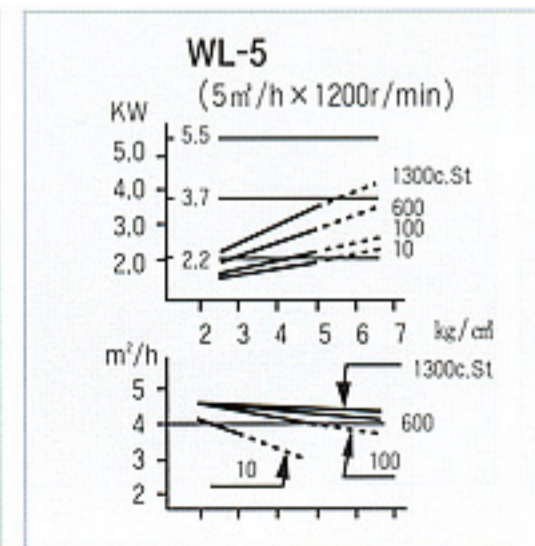
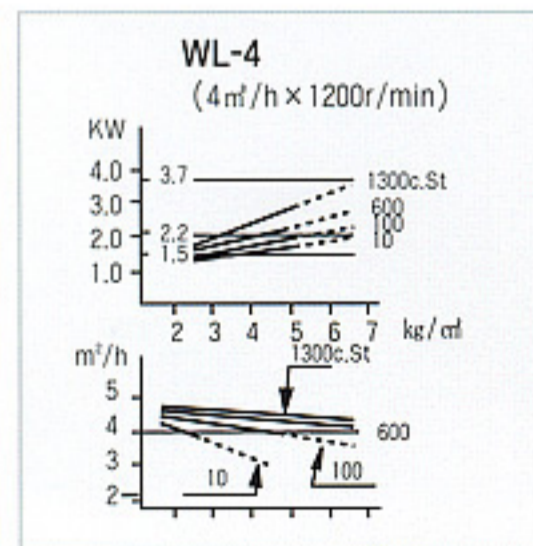
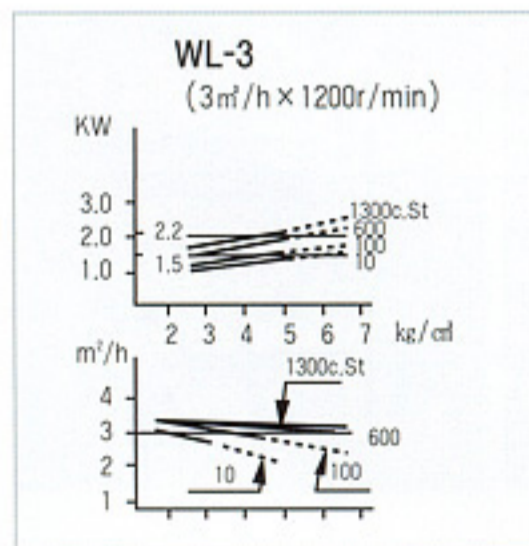
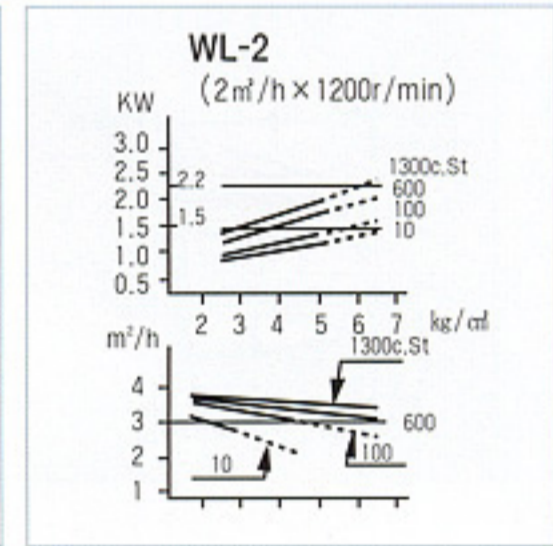
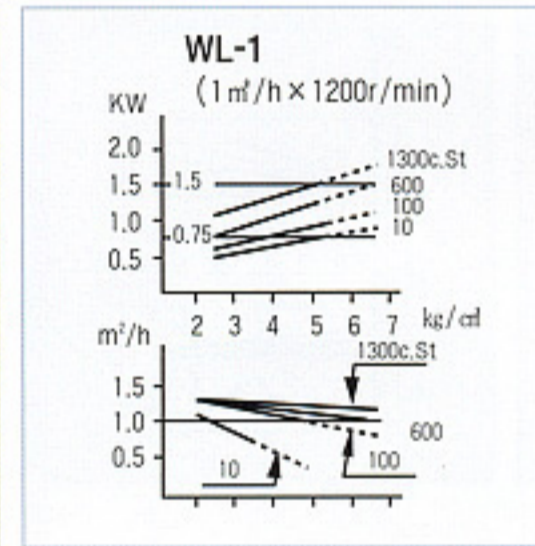
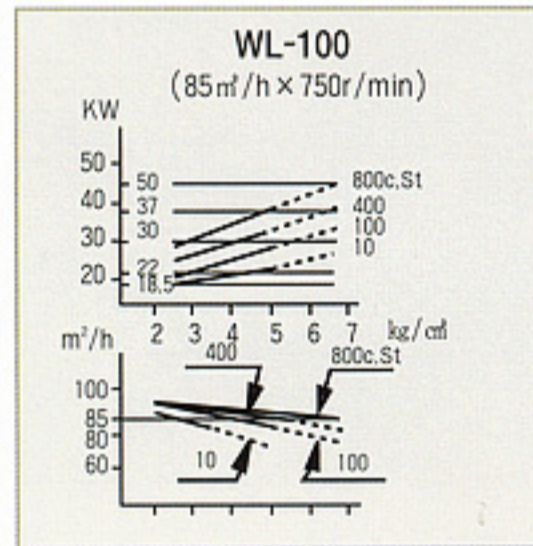
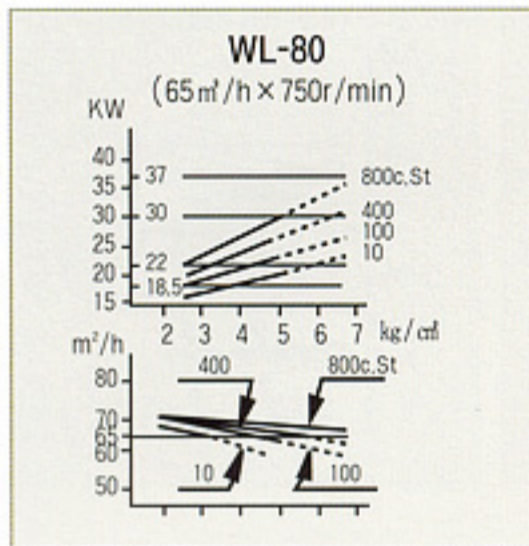
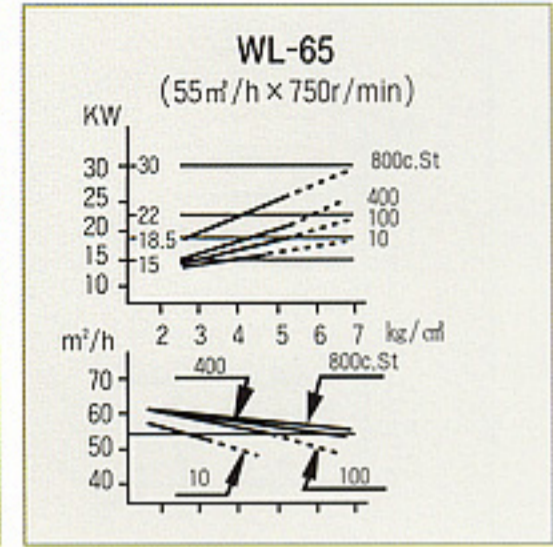
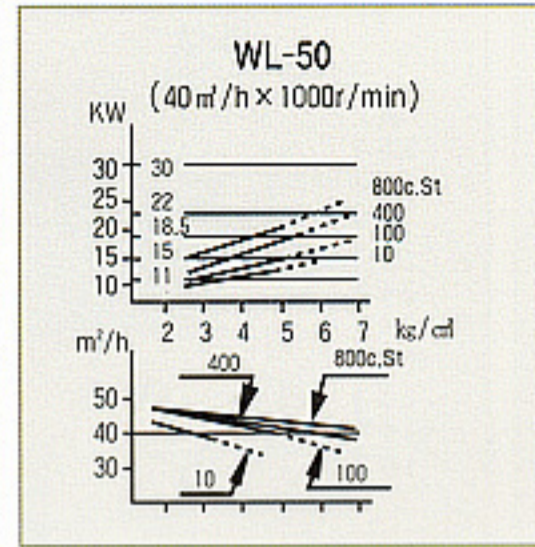
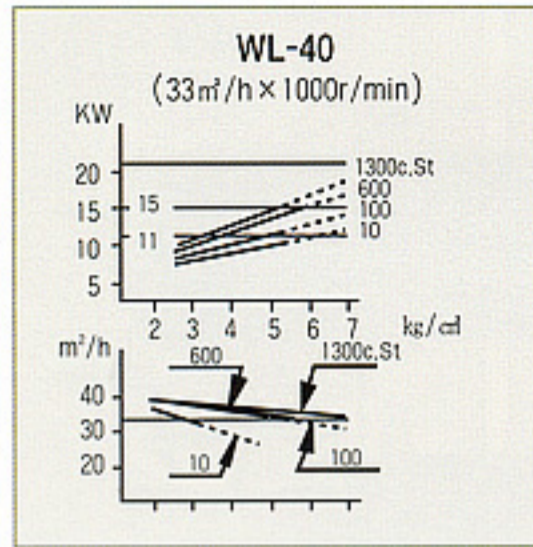
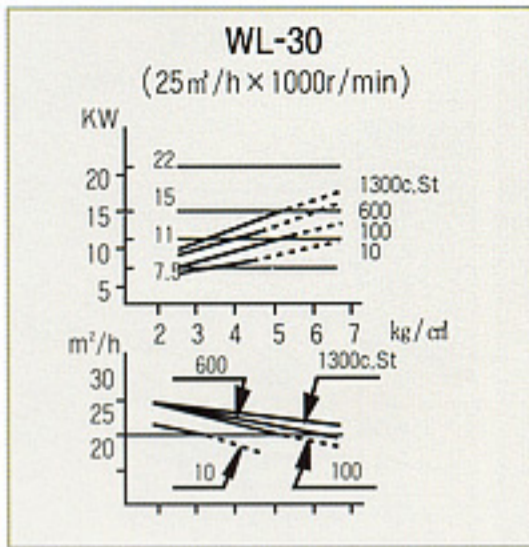

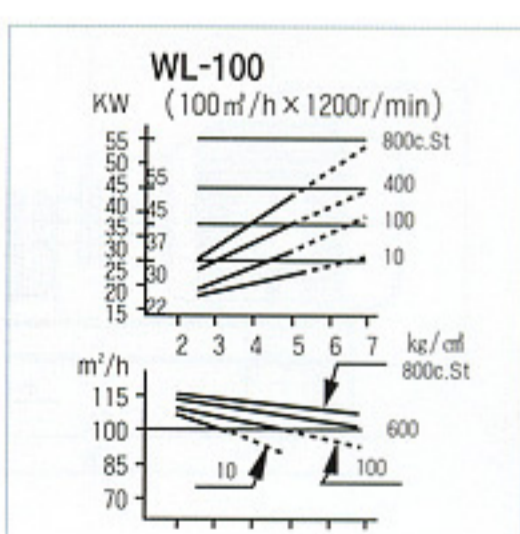
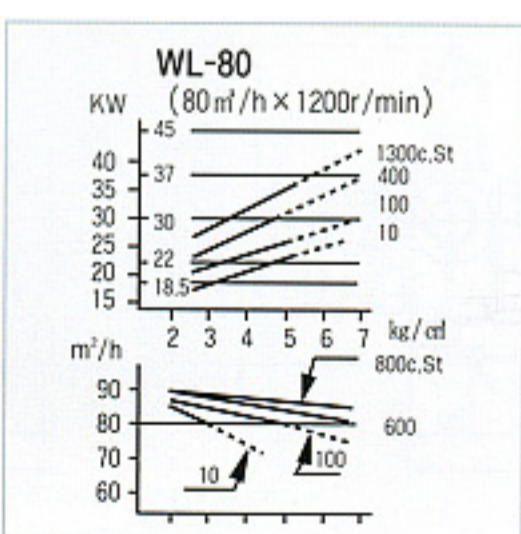
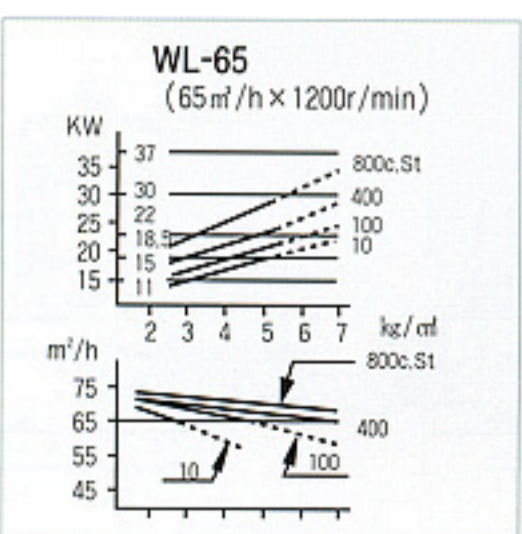
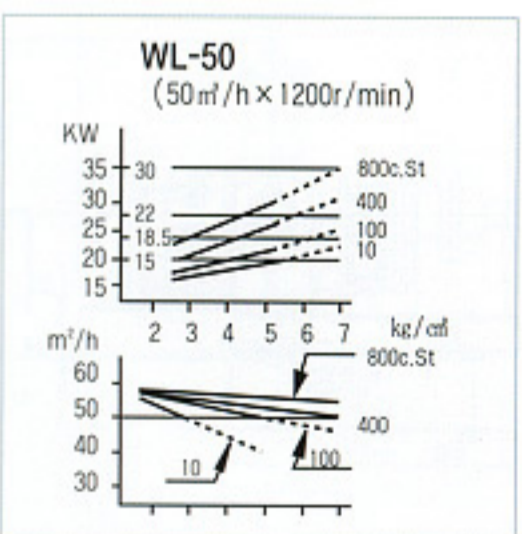
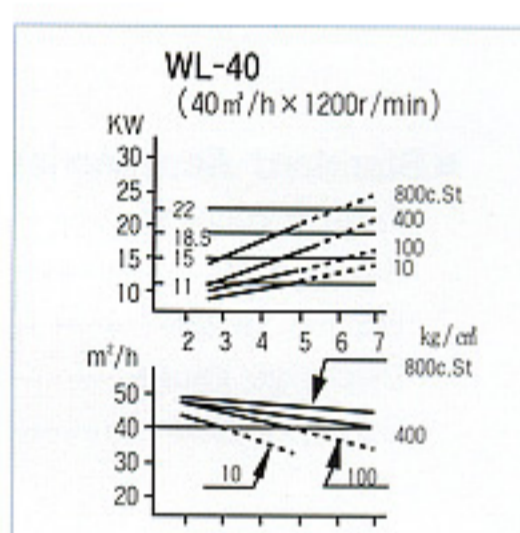
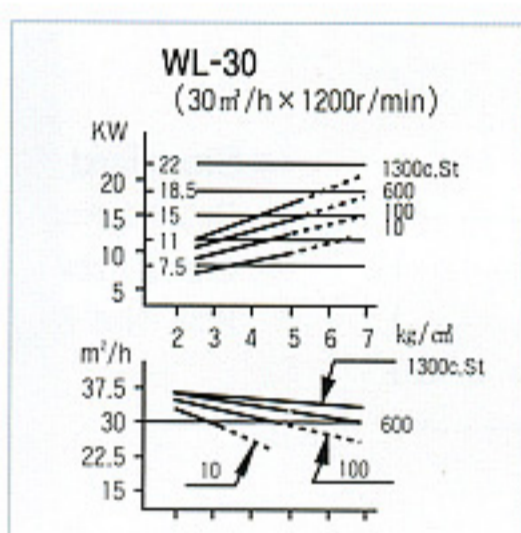
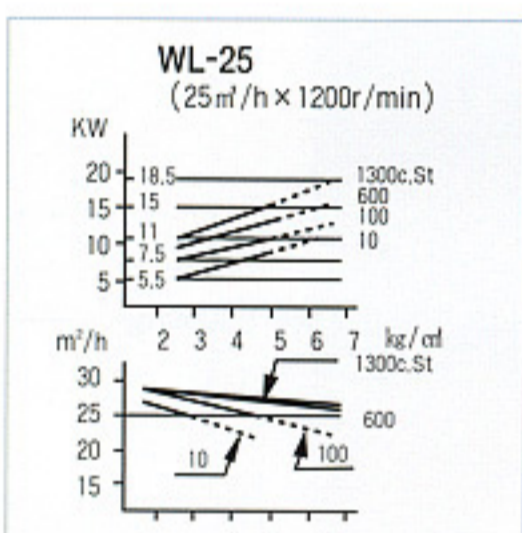
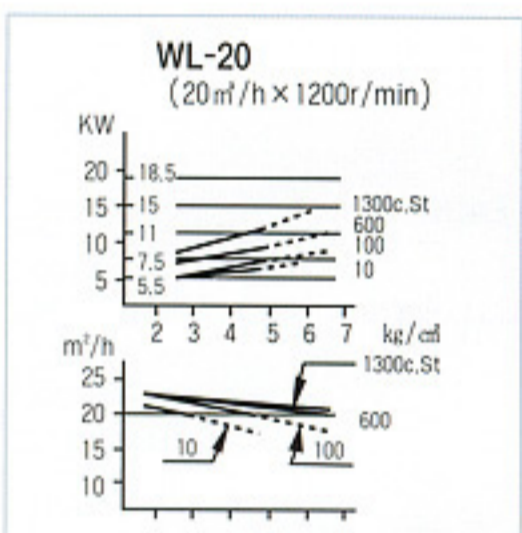
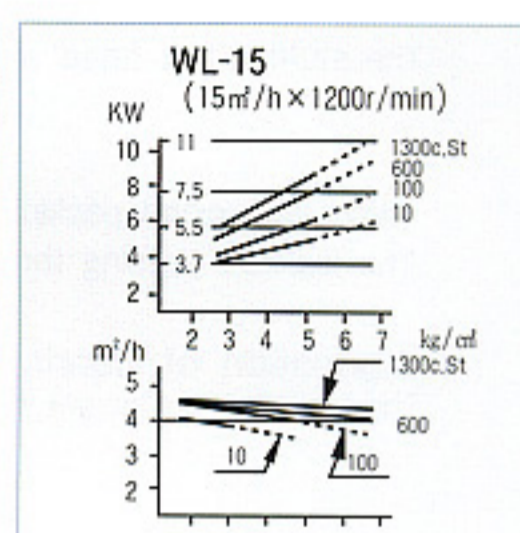
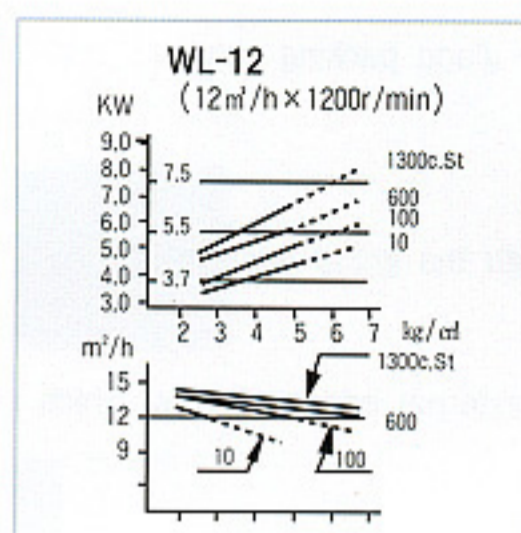
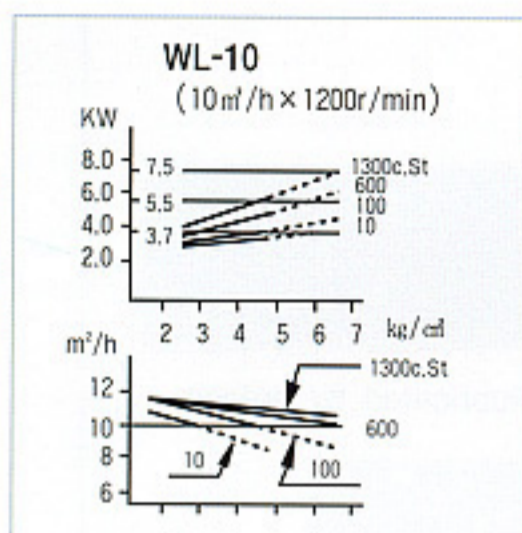
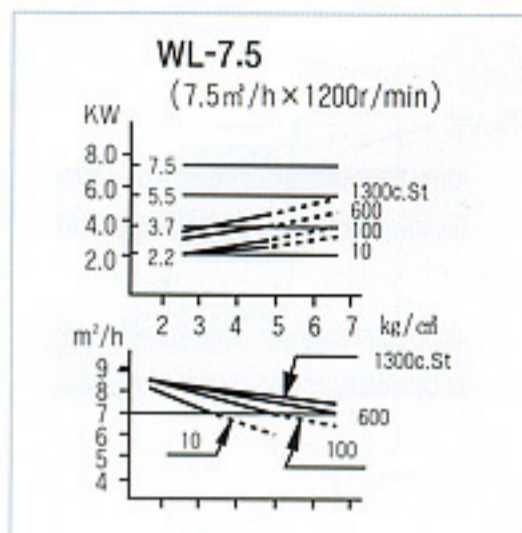

■ Stuffing Box Seal

The stuffing box fitted with gland packing only.

Fitted with gland packing

The leakage passing through the gland packing is drained to bilge.

■ Lubrication of Bearing

The ball bearing is set in external bearing boxes, which is lubricated by grease.

■ Relief Valve

1. Relief valve is set together with casing body.
2. Capacity of relief valve

Discharge pressure maximum arising value is designed to be less than 132% of designed total pressure, even if the discharge valve is full shutted. (But when designed total pressure is less than 5kgf/cm², the pressure-arising value should be less than 1.6kgf/cm².)

Pressure set for the relief valve.

WL type Designed total pressure +0.2kgf/cm²
 (Highest-7.2kgf/cm² Lowest - 2.2kgf/cm²)

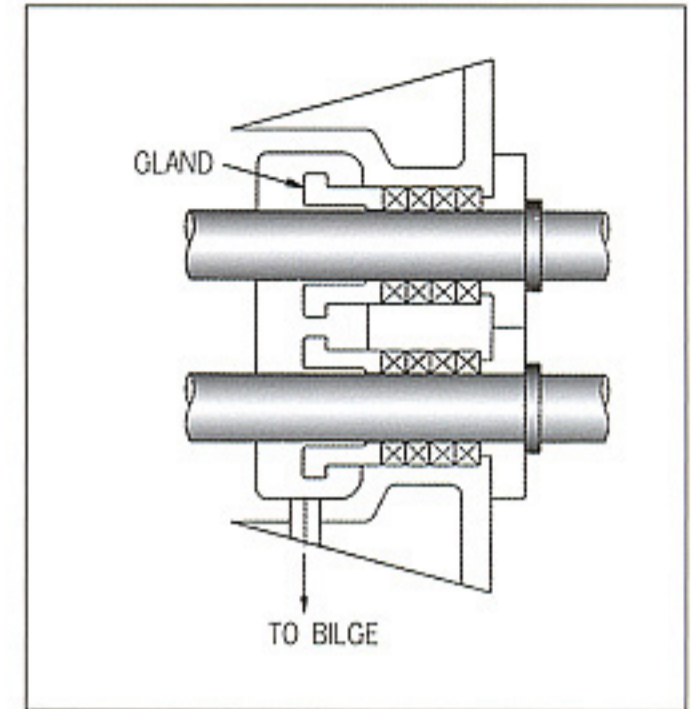

■ Standard Accessories

- Flexible coupling.....1
- Safety cover.....1
- Suction gauge.....1
- Discharge gauge.....1
- Common base.....1

■ Standard Spare Parts

- Ball bearing.....Each1
- Gland Packing.....1
- Bolt, Nut & Washer for flexible coupling.....1 set

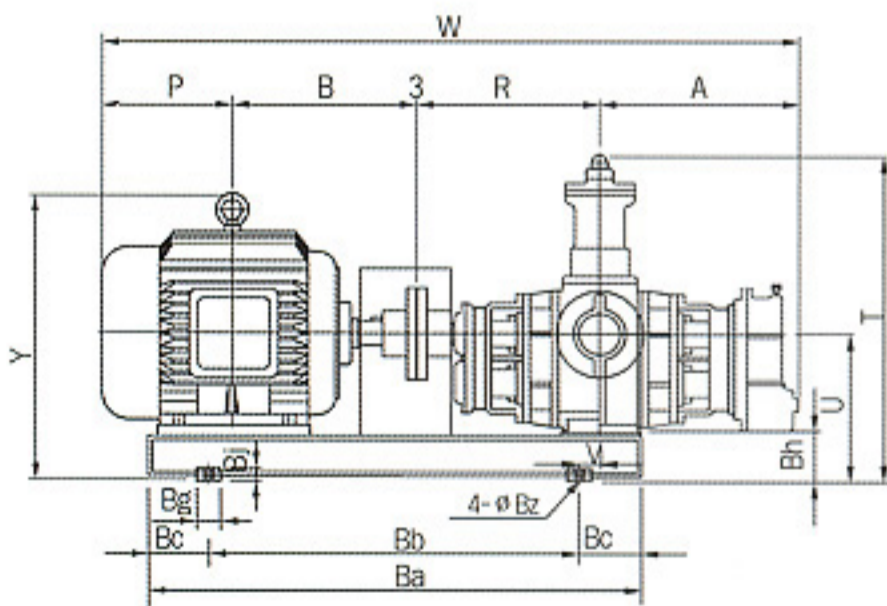

Fig.(a)

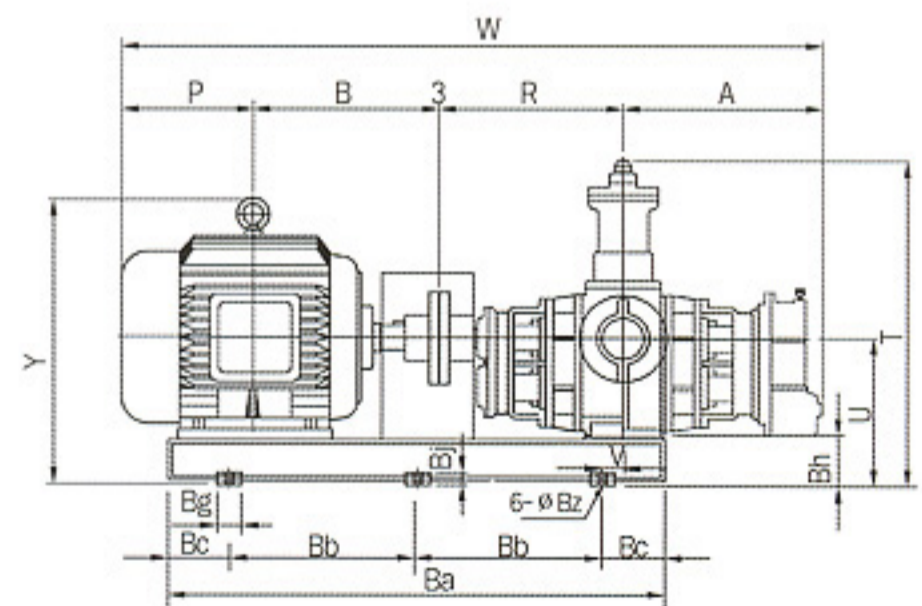
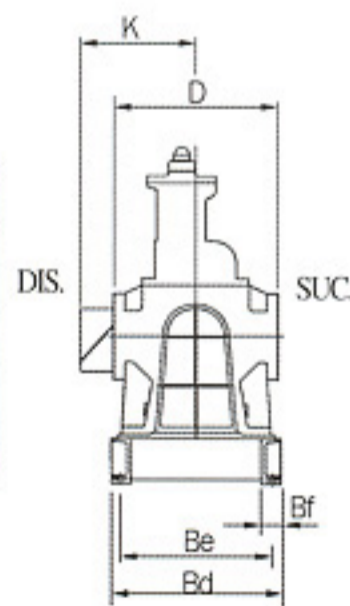
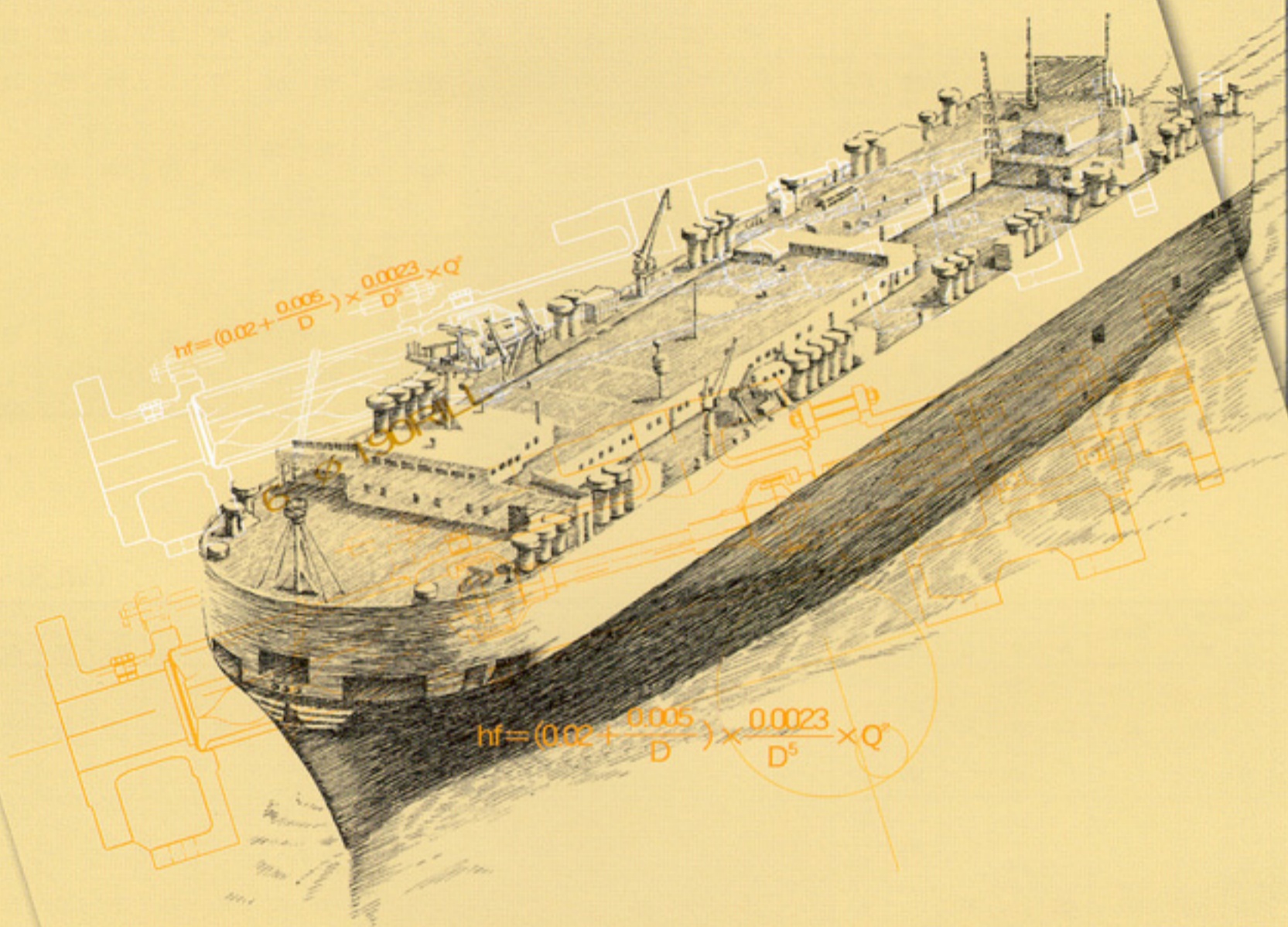

Fig.(b)

MONO SCREW PUMP FOR MARINE



SHIN SHIN MACHINERY CO., LTD.



Homepage : <http://www.sspump.com>

E-mail : sales@sspump.com

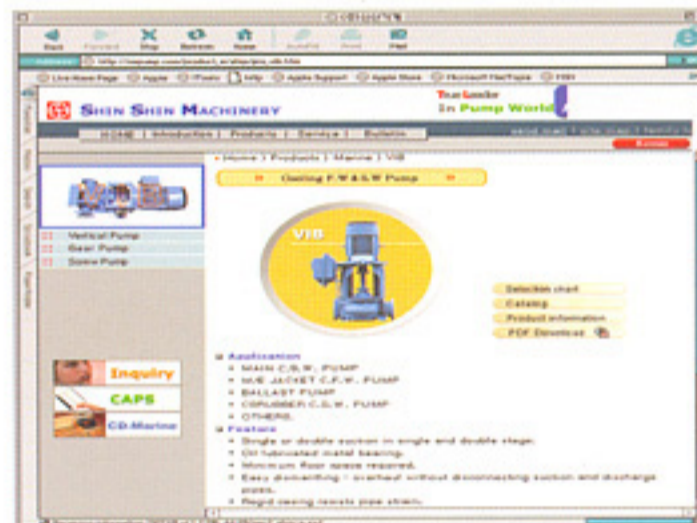

SHIN SHIN MACHINERY CO., LTD.

Head Office & Factory

940-13 Yerim-ri, Chongwan-Myen, Gijang-Gun, Pusan, Korea.

Phone : (051) 727-5300~4

Telefax: (051) 727-5305~8

Seoul Office

Phone : +82-2-752-8419/8403, 778-8832

Telefax: -82-2-755-3156

